

30V N-Channel Mosfet

FEATURES

- $R_{DS(ON)}=10m\Omega(Typ.) @V_{GS}=10V$
- $R_{DS(ON)}=15m\Omega(Typ.) @V_{GS}=4.5V$

APPLICATIONS

- Motor Control and Drive
- Uninterruptible Power Supply (UPS)
- Battery Management

SOT-23-3L

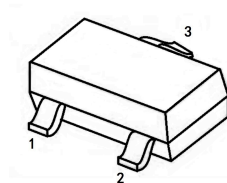

1. GATE
2. SOURCE
3. DRAIN

N-CHANNEL MOSFET

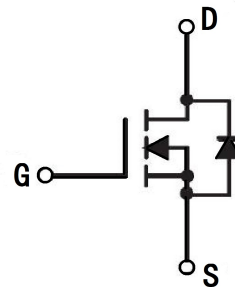

MAXIMUM RATINGS (Ta=25°C unless otherwise noted)

Symbol	Parameter	Max.	Units	
V_{DSS}	Drain-Source Voltage	30	V	
V_{GSS}	Gate-Source Voltage	± 20	V	
I_D	Continuous Drain Current	$T_a = 25^\circ C$	7	A
		$T_a = 100^\circ C$	5	A
I_{DM}	Pulsed Drain Current <small>note1</small>	28	A	
P_D	Power Dissipation	$T_a = 25^\circ C$	1.25	W
$R_{\theta JA}$	Thermal Resistance, Junction to Ambient	100	$^\circ C/W$	
T_J, T_{STG}	Operating and Storage Temperature Range	-55 to +150	$^\circ C$	

MOSFET ELECTRICAL CHARACTERISTICS Ta=25 °C unless otherwise specified

Symbol	Parameter	Test Condition	Min.	Typ.	Max.	Units
Off Characteristic						
$V_{(BR)DSS}$	Drain-Source Breakdown Voltage	$V_{GS} = 0V, I_D = 250\mu A$	30	-	-	V
I_{DSS}	Zero Gate Voltage Drain Current	$V_{DS} = 24V,$ $V_{GS} = 0V, T_J = 25^\circ C$	-	-	1	μA
I_{GSS}	Gate to Body Leakage Current	$V_{GS} = \pm 20V$	-	-	± 100	nA
On Characteristics						
$V_{GS(th)}$	Gate Threshold Voltage	$V_{DS} = V_{GS}, I_D = 250\mu A$	1.0	1.5	2.5	V
$R_{DS(on)}$	Static Drain-Source	$V_{GS} = 10V, I_D = 5A$	-	10	13	m Ω
	On-Resistance <small>note2</small>	$V_{GS} = 4.5V, I_D = 5A$	-	15	18	m Ω
Dynamic Characteristics						
C_{iss}	Input Capacitance	$V_{DS} = 15V, V_{GS} = 0V,$ $f = 1.0MHz$	-	470	-	pF
C_{oss}	Output Capacitance		-	62	-	pF
C_{rss}	Reverse Transfer Capacitance		-	53	-	pF
Q_g	Total Gate Charge	$V_{DS} = 15V, I_D = 2A,$ $V_{GS} = 10V$	-	12.4	-	nC
Q_{gs}	Gate-Source Charge		-	1.7	-	nC
Q_{gd}	Gate-Drain("Miller") Charge		-	2.4	-	nC
Switching Characteristics						
$t_{d(on)}$	Turn-On Delay Time	$V_{GS} = 10V, V_{DS} = 15V,$ $R_G = 2\Omega, I_D = 2A$	-	4	-	ns
t_r	Turn-On Rise Time		-	3.3	-	ns
$t_{d(off)}$	Turn-Off Delay Time		-	20	-	ns
t_f	Turn-Off Fall Time		-	3.5	-	ns
Drain-Source Diode Characteristics and Maximum Ratings						
I_S	Maximum Continuous Drain to Source Diode Forward Current		-	-	7	A
I_{SM}	Maximum Pulsed Drain to Source Diode Forward Current		-	-	28	A
V_{SD}	Drain to Source Diode Forward Voltage	$V_{GS} = 0V, I_{SD} = 2A,$ $T_J = 25^\circ C$	-	-	1.2	V

Notes: 1. Repetitive Rating: Pulse width limited by maximum junction temperature

2. Pulse Test: Pulse width $\leq 300\mu s$, Duty Cycle $\leq 1\%$

Typical Performance Characteristics

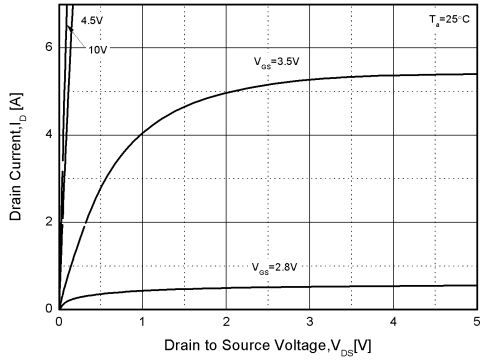

Figure1. Output Characteristics

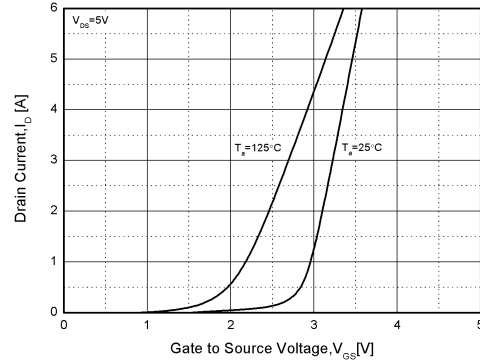

Figure2. Transfer Characteristics

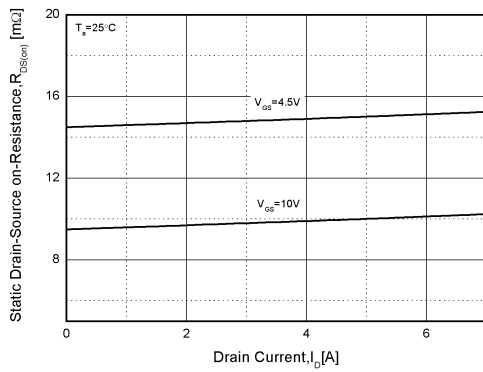

Figure3. Rdson-Drain Current

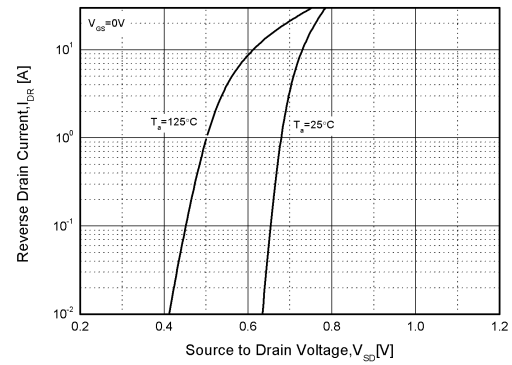

Figure4. Typical Source-Drain Diode Forward Voltage

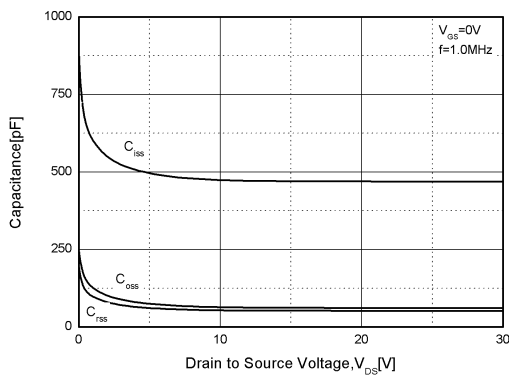

Figure5. Capacitance Characteristics

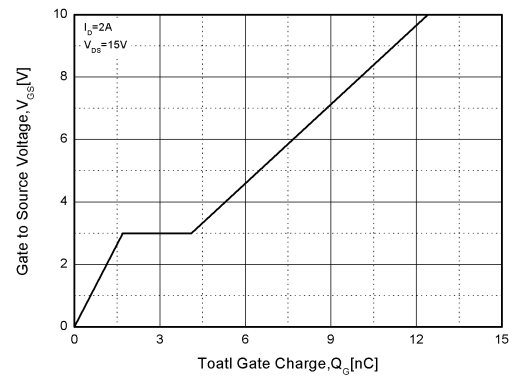

Figure6. Gate Charge

Typical Performance Characteristics (cont.)

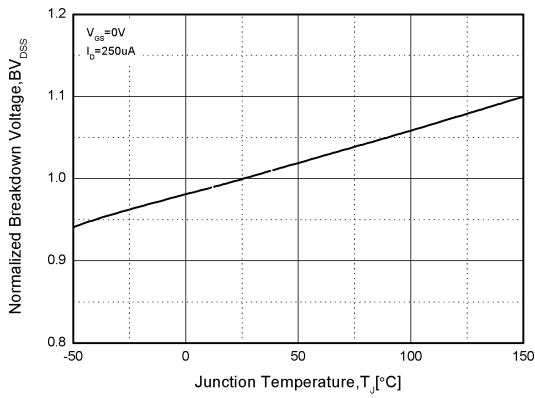

Figure7. Normalized Breakdown Voltage vs. Temperature

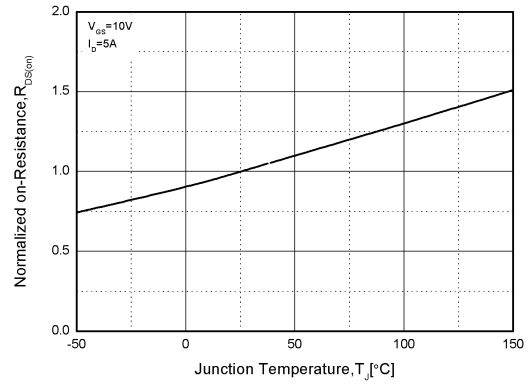

Figure8. Normalized on Resistance vs. Temperature

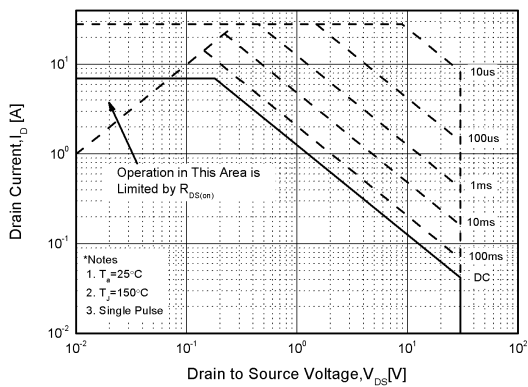

Figure9. Safe Operation Area

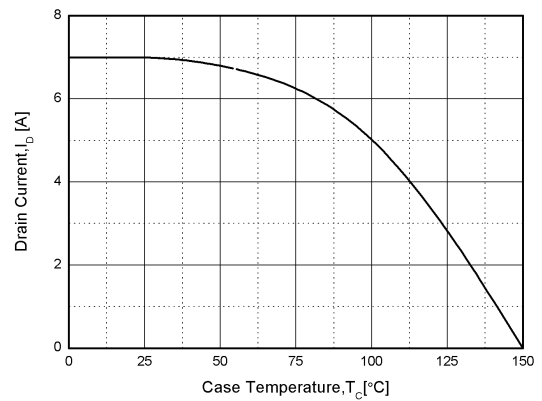

Figure10. Drain Current vs. Case Temperature

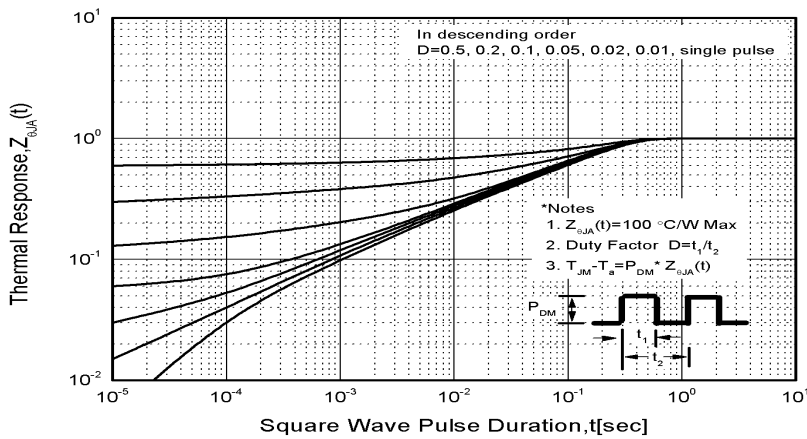
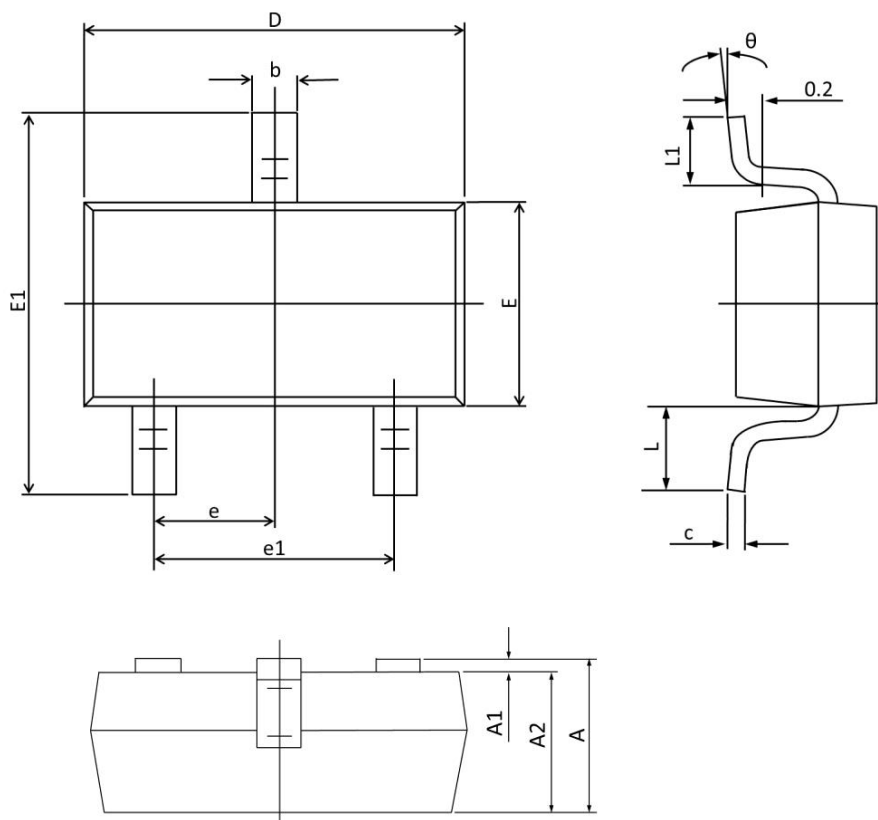

Figure11. Transient Thermal Response Curve

SOT-23-3L PACKAGE OUTLINE DRAWING



Symbol	Dimensions In Millimeters		Dimensions In Inches	
	Min	Max	Min	Max
A	1.050	1.250	0.041	0.049
A1	0.000	0.100	0.000	0.004
A2	1.050	1.150	0.041	0.045
b	0.300	0.400	0.012	0.016
c	0.100	0.200	0.004	0.008
D	2.820	3.020	0.111	0.119
E	1.500	1.700	0.059	0.067
E1	2.650	2.950	0.104	0.116
e	0.950 TYP.		0.037 TYP.	
e1	1.800	2.000	0.071	0.079
L	0.700 REF.		0.028 REF.	
L1	0.300	0.600	0.012	0.024
θ	0°	8°	0°	8°